

# Oxygen Concentrator

Model: 7F-3 / 7F-5B

## User's Manual



**DO NOT OPERATE THIS UNIT WITHOUT FIRST  
READING AND UNDERSTANDING THIS MANUAL**

## **TABLE OF CONTENTS**

---

SAFETY NOTES.....	2-6
FEATURES.....	7-9
HANDLING.....	10
OPERATING & INSTALLATION.....	11-16
MAINTENANCE.....	17-18
TROUBLESHOOTING.....	19-20
OTHER ATTENTION ITEMS.....	21-22
EMC INFORMATION.....	23-25

## **SAFETY NOTES**

### **WARNING:**

**INDICATION FOR USE:** This device designed to extract oxygen from atmospheric air. It will typically be an electrically-powered molecular sieve (artificial zeolite) used to separate nitrogen from room air. The oxygen concentration is variable, depending on the flow rate being utilized.



**INTENDED USE:** This oxygen concentrator is intended for individual use as an oxygen supplement device in the professional healthcare facility and home healthcare environment. It provides high concentration of oxygen to patients with respiratory disorders e.g. COPD (Chronic Obstructive Pulmonary Disease), LTOT (Long Term Oxygen Therapy) etc.

**Users who require continuous oxygenation must plan for alternate reserve sources of power and oxygen in the event of a failure or loss of power and oxygen. This device is to be used as an oxygen supplement and is NOT considered life-supporting or life-sustaining.**

### **WARNING:**

**CONTRACTIONS:** Oxygen poisoning and oxygen allergy user/patient **DO NOT** using this oxygen concentrator.

**SIDE EFFECT:** No side effect.

Symbol	Description
	Describes a hazard or unsafe practice that if not avoided can result in severe bodily injury, death or property damage.
	Describes a hazard or unsafe practice that if not avoided can result in minor bodily injury or property damage.

### **I . IMPORTANT MESSAGE**

- To reduce the risk of electrical shock, **DO NOT** remove the cabinet. Refer service to qualified service personnel.
- Before operating the device, read and understand this manual.
- The patient is an intended operator.

### **II . BEFORE INSTALLATION**

- The concentrator should always be kept upright to prevent cabinet damage while being transported.
- If the electrical source power voltage is unstable that beyond normal power rang, please add the voltage stabilizer.
- Please use eligible, safe power set and junction box.
- Non-professional people **DO NOT** open oxygen concentrator's cabinet.

### **III.LOCATING**

- You may select a room in your house where using your oxygen concentrator would be most convenient. Your concentrator can easily move from one room to other room by the wheels.

## **SAFETY NOTES**

---

- Be certain to place the device so all sides are at least 10 cm (4 inches) away from walls, draperies, furniture, or other obstruction. **MUST** place the oxygen concentrator in a well-ventilated area.
  - Always place the device in the expected position that the operator can hear the audio alarming.
  - Oxygen concentrator **MUST** locate so as to avoid pollutants or fumes.
  - Oxygen concentrator must avoid heat source, fire source, wetness, exorbitant or over-low extra ventricular condition.
  - Sundries and vessel do not be placed on top of the concentrator.
- NEVER** block the air openings of the unit or place it on a soft surface, such as a bed or couch, where the air opening may be blocked. Keep the openings free from lint, hair and the like.

## **IV.USING**

- The use of oxygen therapy requires that special care be taken to reduce the risk of fire. Users **MUST NOT SMOKE** while using this device. Keep all matches, lighted cigarettes or other sources of ignition out of the room in which this product is located. **NO SMOKING** signs should be prominently displayed. Textiles and other materials that normally would not burn are easily ignited and burn with great intensity in oxygen enriched air. Failure to observe this warning can result in severe fire, property damage and cause physical injury or death.
- It can take up to 10 minutes to stabilize to deliver the set flowrate and concentration of oxygen to user after switching on the oxygen concentrator.
- For optimum performance, do not open or turn off the concentrator frequently, reset after 3~5 minutes. Shorter periods of operation may reduce maximum product life.
- A spontaneous and violent ignition may occur if oil, grease or greasy substances come in contact with oxygen under pressure. These substances **MUST** be kept away from the oxygen concentrator, tubing and connections, and all other oxygen device.
- **DO NOT** use any lubricants unless recommended by manufacturer.

## **V. MAINTENANCE**

The oxygen concentrator was specifically designed to minimize routine preventive maintenance at intervals of once per year. Only professionals of the healthcare field or persons fully conversant with this process such as authorized or factory trained personnel should perform preventive maintenance or performance adjustments on the oxygen concentrator.

## **SAFETY NOTES**

---

### **VI. RADIO FREQUENCY INTERFERENCE**

This equipment generates, uses and can radiate radio frequency energy and, if not installed according with the instructions, may cause harmful interference to other devices in the vicinity. However, there is no guarantee that interference will not occur in a particular installation. If this equipment does cause harmful interference to other devices, which can be determined by turning the equipment off and on, the user is encouraged to try to correct the interference by one or more of the following measures:

- Reorient or relocate the receiving device.
- Increase the separation distance between the equipment.
- Connect the equipment into an outlet on a circuit different from that which the other device(s) are connected.
- Consult the manufacturer or service technician for help.

### **VII. TO REDUCE THE RISK OF BURNS, ELECTROCUTION, FIRE OR INJURY TO PERSONS**

- Avoid using while bathing. If continuous usage is required by the physician's prescription, the oxygen concentrator must be located in another room at least 2.5m from the bath.
- **DO NOT** come in contact with the oxygen concentrator while wet.
- **DO NOT** place or store oxygen concentrator where it can drop into water or other liquid.
- **DO NOT** reach for oxygen concentrator that has fallen into water. **UNPLUG IT IMMEDIATELY.**
- Oxygen concentrator should **NEVER** be left unattended when plugged in.
- Oxygen concentrator is to be used only in accordance with the prescription of a physician and this User's Manual. If at any time the patient or attendant concludes that the patient is receiving an insufficient amount of oxygen, the supplier and/or physician should be contacted immediately. No adjustments should be made to the flowrate unless prescribed by a physician.
- The oxygen delivery setting has to be determined for each patient individually with the configuration of the equipment to be used, including accessories, by the physician's prescriptions.
- Close supervision is necessary when the oxygen concentrator is used near children or physically-challenged individuals.
- Use the oxygen concentrator for only intended use as described in this manual.
- **DO NOT** use parts, accessories or adapters other than those authorized by manufacturer.

## **SAFETY NOTES**

---

- **DO NOT** connect the oxygen concentrator in parallel or series with other oxygen concentrators or oxygen therapy devices.
- Use of some administration accessories or certain humidifiers not specified for use with oxygen concentrator may impair the performance.
- In certain circumstances oxygen therapy can be hazardous. Manufacturer recommends that you seek medical advice before using this product.
- Avoid creation of any spark near medical oxygen equipment. This includes sparks from static electricity created by any type of friction.
- The oxygen delivery settings of the oxygen concentrator should periodically reassessed for the effectiveness of the therapy.
- To reduce the risk of infecting another user or operator of reuse the oxygen concentrator, the cabinet should be cleaned by **a mild household cleaner** before reuse. And all external tubing, cannula, humidifier or other accessory should be replaced.
- The shelf life of the device is 3 years after manufacturing (**includes all components, excepts single use consumable materials**). And the Service Life is equal to the shelf life.
- Be aware that the power cord and/or tubing could present a tripping or strangulation hazard. **Always place the power cord and/or tubing in a manner that prevents crushing by casters or others.**
- **DO NOT** modify the oxygen concentrator in any way. Modifications could result in hazards to the user.



There is a risk of fire associated with oxygen enrichment during oxygen therapy. Do not use the oxygen concentrator or accessories near sparks or open flames.



To ensure receiving the therapeutic amount of oxygen delivery according to your medical condition, **7F-3/7F-5B** Oxygen Concentrator **by YUWELL** must

- be used only after one or more settings have been individually determined or prescribed for you at your specific activity levels.

- be used with the specific combination of parts and accessories that are in line with the specification of the concentrator manufacturer and that were used while your settings were determined.



Use only water-based lotions or salves that are oxygen-compatible before and during oxygen therapy. Never use petroleum or oil-based lotions or salves to avoid the risk of fire and burns.

## SAFETY NOTES

---



Do not lubricate fittings, connections, tubing, or other accessories of the oxygen concentrator to avoid the risk of fire and burns.



Use only spare parts recommended by the manufacturer to ensure proper function and to avoid the risk of fire and burns.



Use of this device at an altitude above 2000m or outside temperature of 5°C~40°C or relative humidity above 90% is expected to adversely affect the flowrate and the percentage of oxygen and consequently the quality of the therapy.



Oxygen makes it easier for a fire to start and spread. Do not leave the nasal cannula or mask on bed coverings or chair cushions, if the oxygen concentrator is turned on, but not in use; the oxygen will make the materials flammable. Turn the oxygen concentrator off when not in use to prevent oxygen enrichment.



If you feel discomfort or are experiencing a medical emergency while undergoing oxygen therapy, seek medical assistance immediately to avoid harm.



Geriatric, paediatric or any other patient unable to communicate discomfort can require additional monitoring and or a distributed alarm system to convey the information about the discomfort and or the medical urgency to the responsible care giver to avoid harm.



Smoking during oxygen therapy is dangerous and is likely to result in facial burns or death. Do not allow smoking within the same room where the oxygen concentrator or any oxygen carrying accessories are located.

If you intend to smoke, you must always turn the oxygen concentrator off, remove the cannula and leave the room where either the cannula or mask or the oxygen concentrator is located. If unable to leave the room, you must wait 10 minutes after you have turned the oxygen concentrator off before smoking.



Open flames during oxygen therapy are dangerous and is likely to result in fire or death. Do not allow open flames within 2 m of the oxygen concentrator or any oxygen carrying accessories.

## FEATURES

---

### I. SUMMARY

The oxygen concentrator is intended for individual use in the professional healthcare facility and home healthcare environment. It is an electronically operated device that separates oxygen from room air. It provides high concentration of oxygen directly to you through a nasal cannula. Clinical studies have documented that oxygen concentrators are therapeutically equivalent to other types of oxygen delivery systems. This user's manual will tell you about your concentrator and will serve as a reference as you use your concentrator.

### II. CHARACTERS

- Complete plastic out shell, safe and reliable.
- Timing accumulates function, show total operating hours through the display screen.
- Timing turns off function using convenience.
- Compressor pressure relief valve help the device safer.
- Power interruption alarm function.
- Device failure alarm function (including pressure failure, compressor failure, low oxygen concentration).
- Compressor with over heat protect function to gain in safety of the compressor and the concentrator.
- 

### III. SPECIFICATIONS

1. Power Supply: ~230V, 50Hz
2. Input Power: **【7F-3】 320VA; 【7F-5B】 400VA**
3. Maximum Recommend Flow Rate: **【7F-3】 3L/min; 【7F-5B】 5L/min**
4. Oxygen Concentration at Nominal Output Pressure of 0kPa (Measured after warm up 30minutes) : **【7F-3】 3L/min: 93±3%; 【7F-5B】 5L/min: 95.5%~87%**
5. Maximum limited pressure: **50kPa ( with humidifier bottle )**
6. Sound Pressure Level & Sound Power Level :  
**【7F-3】 : 3L/min, Sound Pressure ≤55dB(A), Sound Power≤60dB(A);**  
**【7F-5B】 : 5L/min, Sound Pressure ≤55dB(A), Sound Power≤60dB(A);**
7. Audio Alarm:  
**50dB(A) or greater when failure alarm;**  
**50dB(A) or greater when power lost;**



## FEATURES

---

### 8. Oxygen Concentration vs. Oxygen Flow:

Tested at standard temperature and pressure dry conditions. (101.3kPa, 20°C, dry)

#### 【7F-3】

Flow ( L/min )	Oxygen Concentration ( % )
0.5	93±3%
1	93±3%
2	93±3%
3	93±3%
4	80%~86%
5	70%~80%

#### 【7F-5B】

Flow ( L/min )	Oxygen Concentration ( % )
0.5	95.5%~87%
1	95.5%~87%
2	95.5%~87%
3	95.5%~87%
4	95.5%~87%
5	95.5%~87%

9. Altitude: Not higher than 2000 meters above sea level.

10. Net Weight: 24kg

Dimension: 47×28.5×55.6 (cm)

11. Work system: work continuously.

12. Minimum Operating Time: 30minutes

13. Electric classification: class II equipment, type BF applied part, IP21

14. Electric classification:

over voltage category: II      pollution degree: 2      altitude : ≤2000m

## FEATURES

---

### 15. Safety System:

- Over Current or Connection Loosen (Loss Power): Alarming and Shut Down
- Compressor Over Hot: Unit Shut Down
- Pressure Failure: Alarming and Shut Down
- Compressor Failure: Alarming and Shut Down
- Low Oxygen Concentration

### 16. Normal Operating Condition (with Oxygen Concentration Status Indicator):

- Temperature range: 5°C~40°C
- Relative humidity: 15%~90%
- Atmosphere pressure: 860hPa~1060hPa

Note: When operating condition over the rated ranges of ambient temperature, humidity and atmosphere pressure, the performance of the oxygen may be dropped.

### 17. Oxygen Output Temperature: $\leq 46^{\circ}\text{C}$

Applied part Temperature (Nasal Cannula) :  $\leq 41^{\circ}\text{C}$  in normal condition

Applied part Temperature (Nasal Cannula) :  $\leq 43^{\circ}\text{C}$  in single fault condition

### 18. Cannula length **DO NOT** more than 15.2m and no twist.

### 19. Storage and Transportation Condition:

- Temperature range:  $-20^{\circ}\text{C}\sim 60^{\circ}\text{C}$
- Relative humidity: 10%~93% Non-condensing.
- Atmosphere pressure: 700hPa~1060hPa



The device should be stored with no strong sunlight, no corrosive gas and well ventilated indoor area. The device must be transported and used in the vertical position only.



When the oxygen concentrator is stored outside the temperature range specified under normal operating condition, please put the device in normal operating condition more than 4 hours before operating.

### 20. The maximum oxygen flow for the accessories is not greater than 10L/min. And the maximum pressure for the accessories is not greater than 200 kPa.

## **HANDLING**

---

### **I . UNPACKING**



**CAUT**

Unless use the oxygen concentrator, retain containers and packing materials for storage until use of the concentrator is required.

1. Check for any obvious damage to the carton or its contents. If damage is evident, please notify the carrier or local dealer.
2. Remove all loose packing from the carton.
3. Carefully remove all the components from the carton.

### **II . INSPECTION**

1. Examine exterior of the oxygen concentrator for nicks, dents, scratches or other damages.
2. Inspect all components.

### **III . STORAGE**

1. Store the repackaged oxygen concentrator in a dry area.
2. **DO NOT** place other objects on top of the repackaged concentrator.

# OPERATING & INSTALLATION

## I . FEATURE VIEW

**Figure 1: view of the machine**

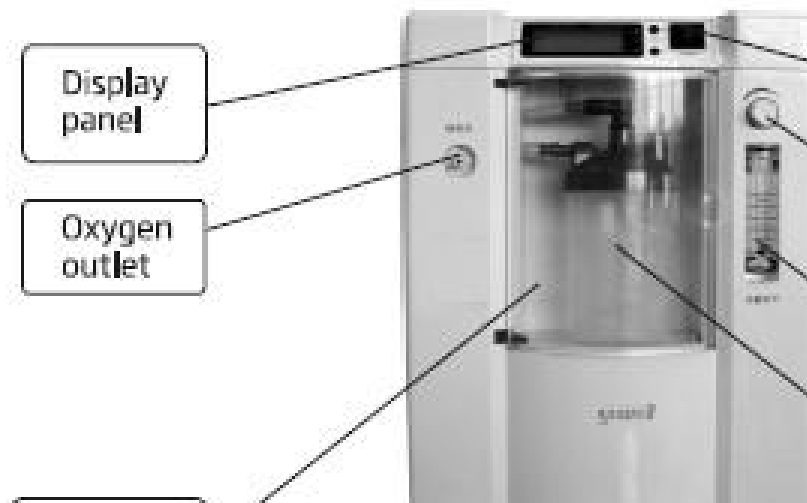

**view of the display panel**

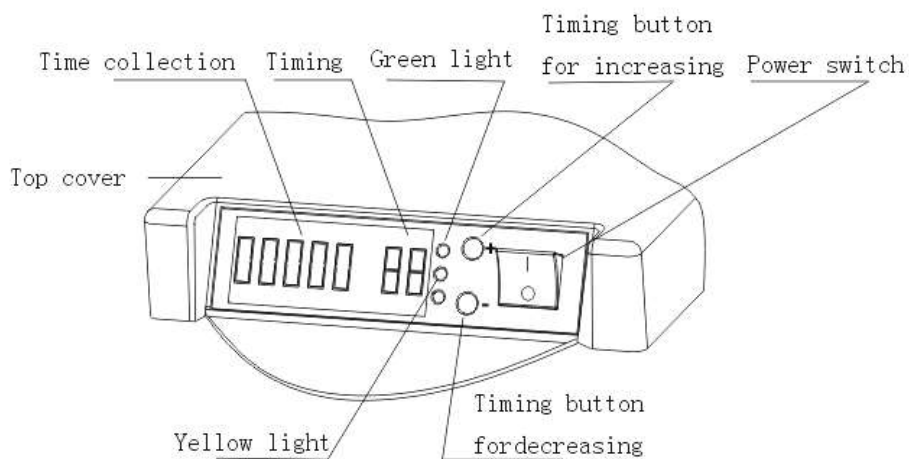

**Figure 2: Humidifier Components**

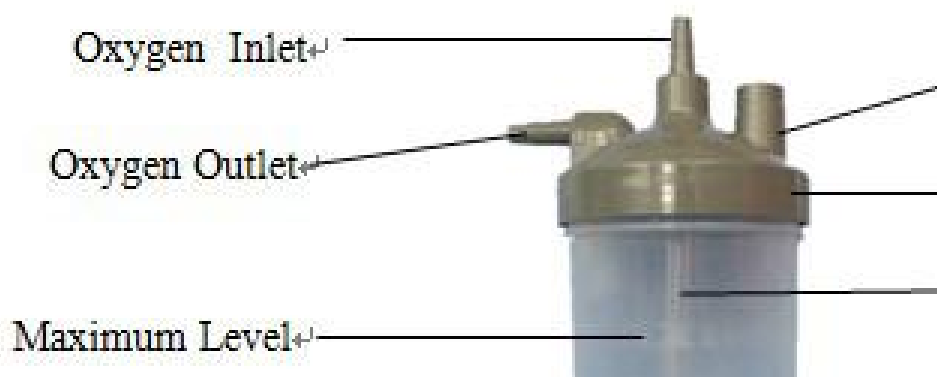

## OPERATING & INSTALLATION

### II. PREPARE WORK

1. Open the transparent door, unscrew the bottle from the humidifier counter-clockwise. Fill the bottle with pure water (or distilled water) to the level indicated by the manufacturer.

2. Screw securely the bottle back counterclockwise.

(Recommend to use Yuwell Humidifier p/n: **20005727** and its preferred location is shown as Figure 1.)

3. **Close the transparent door.**

4. Connect the power supply: Ensure that the power switch is off; plug the concentrator's AC connector into a properly power outlet.

5. **If you want to remove the concentrator , pull out the four caster lockers. ( figure 3 )**



pull out the locker to remove



push down the locker to fix

figure 3



**CAUTION**

1) If the concentrator has a damaged cord or plug, if it is not working properly, if it has been dropped or damaged, or dropped into liquid, call Qualified Service Personnel for examination and repair.

2) Keep the cord away from HEATED or HOT surfaces.

3) Do not move or relocate concentrator by pulling on the cord.

4) Do not use extension cords with this unit.

NOTE: Concentrator may be used during the initial start warm-up time (approximately 30 min) while waiting for the O<sub>2</sub> purity to reach maximum.

### III. OXYGEN ABSORBING OPERATION

1. Turn the power switch to the “|” position. The LCD shows “HELLO”, the green, yellow indicator all light means concentrator is normal. About 1 second later, only green indicator lights. After 4 seconds, the LCD shows elapsed time.

2. Turn the flowrate knob to the setting prescribed by your physician or therapist. ( Figure 4 )

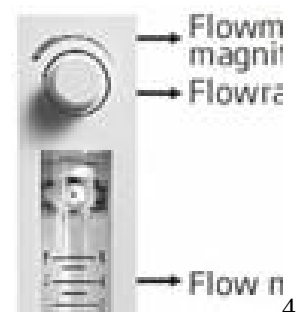

4

## OPERATING & INSTALLATION

NOTE: To properly read the flowrate, locate the prescribed flowrate line on the flowmeter.

Next, turn the flow knob until the ball rises to the line.

Now, center the ball on the L/min line prescribed.

 **CAUTION** If the flowrate on the flowmeter ever falls below 0.5L/min, check tubing or accessories for blocked or kinked tubing or a defective humidifier bottle.

- Meanwhile, humidifier bottle will have air bubble around the diffuser. Then, oxygen comes from the oxygen outlet.

3. Connect the fire safe cannula valve (see the accessories) and the nasal oxygen cannula to the oxygen outlet. ( See Figure 5 )

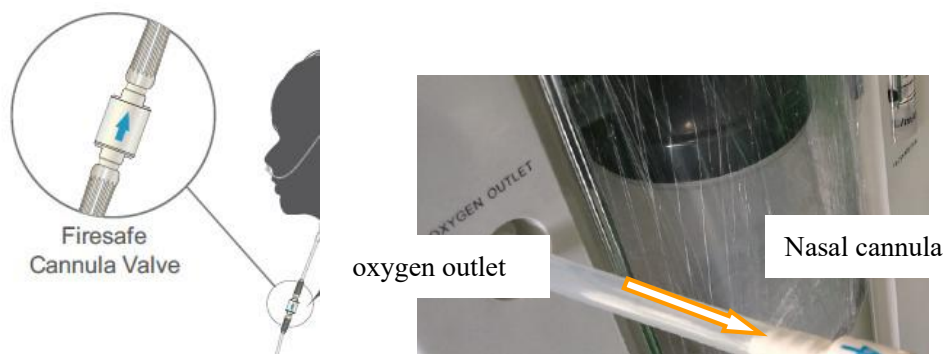

Figure 5

Note: The firesafe valve is a thermal fuse designed to extinguish an oxygen delivery tube fire and stop the flow of oxygen if the tube is accidentally ignited. And the firesafe valve is flow direction-sensitive component, the install direction must correct.

Note: The firesafe valve is maintenance free and has an intended life of 4 years. Dispose of any firesafe valve 4 years after the manufacturing date state on the device label. Once actuated, the firesafe valve cannot be reset and must be discarded.

Note: There is another firesafe valve installed close to the oxygen outlet and inside the cabinet of the oxygen concentrator.

Note: The proper placement and positioning of the prongs of the nasal cannula in the nose is critical to the amount of oxygen delivered to the respiratory system of the patient.

Note: The nasal cannula is single use. Re-using the cannula may increase the re-infection risk.

## OPERATING & INSTALLATION

### IV. ALARM SIGNAL

Concentrator has following failure Alarm function:

- |                             |                       |
|-----------------------------|-----------------------|
| 1) Pressure failure         | 2) Compressor failure |
| 3) Low oxygen concentration | 4) Over temperature   |
| 5) Low flowrate             | 6) Power loss         |



Note: **All the alarms are LOW PRIORITY.**

Alarm can only be ceased by turning off the device.

#### ● Initial startup of the concentrator

When the unit is turned on, the green/yellow lights and alarm will come on about 1 second to ensure the function of the indicators, then the yellow lights and alarm will come off. After 5 minutes later, the oxygen sensor will be operating normally and will control the indicator lights depending on oxygen concentration values. The explanations of the indicator light functions are as follows.

#### ● Explanation of the indicator light and alarm

Symbol	Status	Indicator lights	alarm
I/O	SYSTEM OKAY (O <sub>2</sub> concentration is greater than 82%.)	Green	—
	O <sub>2</sub> concentration is less than 82%.	Yellow	Alarm
	SYSTEM FAILURE (Pressure failure alarm; Or, Compressor circuit failure alarm ; Or , over temperature alarm, <b>low flowrate</b> )	Yellow	Alarm
—	Power loss	—	Alarm

#### ● Alarm signal register

- O<sub>2</sub> concentration is greater than 82%. - Green light illuminates, and panel shows “**elapsed time**” and “**setting time** ——”. Normal Operation.
- O<sub>2</sub> concentration is less than 82%. - yellow light illuminate, alarm sounds, and panel shows “**elapsed time**” and “**setting time** ——”. Call Supplier Immediately. You may continue to use the concentrator unless instructed otherwise by your supplier. Be certain that **BACKUP OXYGEN** is nearby.

## **OPERATING & INSTALLATION**

3. Pressure failure alarm - yellow light illuminates, alarm sounds, and panel shows word “E1” or “E2” . Total unit shutdown. Switch immediately to backup oxygen supply. Call supplier immediately.
4. Compressor failure alarm - yellow light illuminates, alarm sounds, and panel shows word “E3” or “E4” . Total unit shutdown. Switch immediately to backup oxygen supply. Call supplier immediately.
5. Over temperature alarm - yellow light illuminates, alarm sounds, and panel shows word “E3” . Total unit shutdown. Switch immediately to backup oxygen supply. Call supplier immediately.
6. Low flowrate alarm - yellow light illuminates, alarm sounds, and panel shows word “LL” . Total unit shutdown. Switch immediately to backup oxygen supply. Call supplier immediately.
7. Power loss alarm - alarm sound , no display , no machine working. Please check the power input.

NOTE: Concentrator will reach to most stable state after warm-up (approximately 30 minutes).

### **V. TIME SETTING**

User can press the timing button to setting the operating time in 1~99 minutes.

- When it start working, the display shows “elapsed time” and " setting time ——", it means that timing function is closed. It will work continually until power supply cuts off.
- Press the “+” button once, operation time increases 1 minute, holding the button more than 1.5 seconds it will increase continually.
- Press the “-” button once, operation time decrease 1 minute, holding the button more than 1.5 seconds it will decrease continually.

The device will auto turn off and the display will show “00” when finishing timing. Reset timing function.



















### **VI. TURNING OFF**

Take off nasal oxygen cannula from oxygen outlet first, turn off power switch, and then cut off the power source.



## OPERATING & INSTALLATION

### VII. SYMBOLS

Symbol	Description	Symbol	Description
	Alternating current		Caution
	Class II Equipment		Type BF Applied part
	OFF (power disconnection from the mains)		ON (power connection to the mains)
	No open flame: Fire, open ignition source and smoking prohibited		No smoking
	Keep Up		Fragile
	Temperature limit		Humidity limitation
	Atmospheric pressure limitation		Refer to instruction manual
	Keep Dry		Stacking Limitation
	Manufacturer		European Representative
<b>IP21</b>	<p>Enclosures Protection Classification</p> <p>The first characteristic number “2”: Protected against access to hazardous parts with a finger.</p> <p>The second characteristic number “1”: Protected against vertically falling water drops.</p>		

## MAINTENANCE

NOTE: Power should be disconnected before beginning preventive maintenance on the concentrator. The concentrator is specifically designed to minimize routine preventive maintenance at intervals of once per year. In places with high dust or soot levels, maintenance may need to be performed more often. The following must be performed at a minimum of one year in service to assure years of additional reliability.

### I. CLEAN CABINET

 **WARN** CUT OFF the power supply first to avoid electrical shock. **DO NOT** remove device cabinet.

Clean the cabinet with a mild household cleaner and non-abrasive cloth or sponge at least one time a month. **Do Not** drop any liquid into the seam of the device.

### II. CLEAN OR REPLACE FILTER

Please clean or replace the filters in time, it's very important to protect compressor and to extend the device life.

1. Clean the I-stage air inlet once a month. ( Figure 6 )

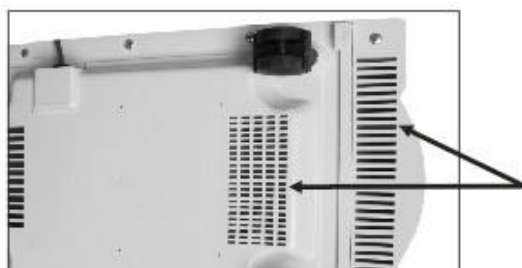

2. The II-stage filter mesh cleans once half a month.

Replace or clean the filter immediately if the mesh turns black. (Figure7)

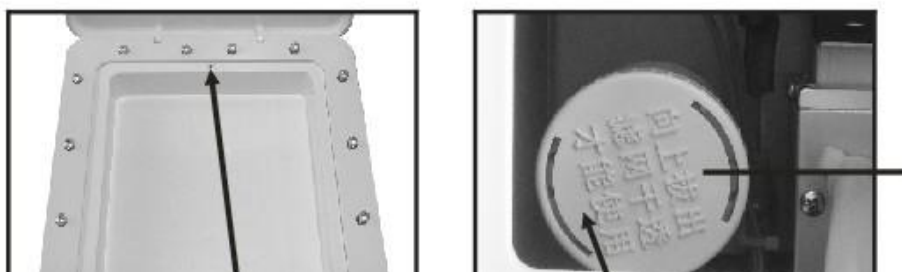

- 1) Clean the filter with a soft cleaner or wash in warm soapy water and rinse thoroughly.
- 2) DRY the filter thoroughly before reinstallation.
- 3) The filter must clean or replace after operating 100 hours operating at least or as necessary.

## MAINTENANCE

---



**CAUTION** *DO NOT* operate the concentrator without installing filter, or while filter is wet. These actions could permanently damage the concentrator.

### 3. Clean Humidifier

- 1) Remove the humidifier bottle from the humidifier cap then clean the bottle.
- 2) Remove the humidifier tube and diffuser then clean them.
- 3) **The humidifier must clean or replace once a week at least or as necessary.**
- 4) **Replace clean water into humidifier every day before using.**

**Note:** During both normal condition and single fault condition, the cabinet, humidifier and nasal cannula can become contaminated with body fluids or expired gases. To reduce the infection risk, please perform the maintenance routinely



### 4. REPLACE FUSE TUBE

Fuse tube for net power (Figure 10)

Type: **T5AH250V~/Φ5×20**



**CAUTION** CUT OFF the power supply first.

Open the top cover, unscrew the screws, and take off the store box. Unscrew fuse box counterclockwise, replace the fuse tube.



## **TROUBLESHOOTING**

Use the table below to take actions when the oxygen concentrator indicates an abnormal condition.

### **TROUBLESHOOTING GUIDE**

<b>Symptom</b>	<b>Probable cause</b>	<b>Solution</b>
Power Interruption Alarm: Press the power on switch on the control panel, alarm, display not lit, device not work.	1) Power cord and wall outlet have poor contact.	1) Re-insert the power cord into wall outlet securely.
	2) Wall outlet no power output.	2) Change to another wall outlet.
	3) Low power of wall outlet.	3) Change to another wall outlet. Do not use any extension cord.
	4) The fuse tube for power break.	4) Replace fuse.
	5) If the device is still not working, please contact the supplier.	
Concentrator is working, the operating sound is normal, the flowmeter knob can be adjusted but no oxygen output or weak output.	1) Leakage between humidifier bottle and cap.	1) Re-install and tighten the humidifier cap.
	2) The safety valve of humidifier is opened.	2) Shake the humidifier slightly to close the safety valve..
	3) The connection between oxygen output and humidifier is leaking.	3) Re-install the humidifier tubing.
	4) The accessory (nasal cannula, mask, humidifier, tubing..., etc.) is leaking.	4) Replace the leaked accessory.
	5) If the phenomenon is still appeared, please contact the supplier.	
Concentrator is working, but <b>yellow</b> light illuminate, <b>alarm</b>	<b>1) Oxygen Concentration <math>\leq</math> 82%.</b>	1) Clean or replace the filter.
	2) Oxygen flow rate over the maximum recommend flow rate: 【7F-3】 3L/min; 【7F-5B】 5L/min	2) Adjust the flow rate only under the advice of a physician.
	3) If the phenomenon is still appeared, the device can be used but please contact the supplier.	
Concentrator is not working, the <b>yellow</b> light illuminate, alarm, the display show “E1”.	1) System cycle pressure is too low.	1) Clean or replace the filter.
	2) If the phenomenon is still appeared, stop using the device, please contact the supplier immediately.	
Concentrator is not working, the <b>yellow</b> light illuminate, alarm, the display show “E2”.	1) System cycle pressure is too high.	1) Stop using the device, please contact the supplier immediately.
	2) If the phenomenon is still appeared, stop using the device, please contact the supplier immediately.	

## TROUBLESHOOTING

Symptom	Probable cause	Solution
Concentrator is not working, the yellow light illuminate, alarm, the display show "E3".	1) Compressor circuit is opened.	1) Stop using the device, please contact the supplier immediately.
	2) inside temperature is too high ;	2) fan failure ; or concentrator air inlet and air outlet blocked ;
	3) If the phenomenon is still appeared, stop using the device, please contact the supplier immediately.	
Concentrator is not working, the yellow light illuminate, alarm, the display show "E4".	1) Compressor circuit is closed.	1) Stop using the device, please contact the supplier immediately.
	2) If the phenomenon is still appeared, stop using the device, please contact the supplier immediately.	
Concentrator is not working, the yellow light illuminate, alarm, the display show "LL".	1) oxygen flowrate is too low.	1) oxygen outlet or tubing accessories is blocked or kinked; or flowrate knob is turn down.
	2) If the phenomenon is still appeared, stop using the device, please contact the supplier immediately.	
The nasal cannula is fogged with vapor or full of liquid drops. (Remove the vapor or liquid drops method: Turn on the device and connect the tubing to the oxygen outlet. Use your finger to block and release the end of the tubing several times to remove the moisture and liquid.)	1) Poor ventilation around the around the device, so operating temperature is too high.	1) Make sure the device is at least 10 cm away from the walls, other jam or heater.
	2) The water which added to humidifier is too hot.	2) Add cold water to humidifier.
	3) Add too many water into humidifier.	3) Water added should between the maximum and minimum levels in humidifier.
	4) The device stops suddenly during operating.	4) Turn off the device immediately. Restart the device to remove the moisture and liquid.
	5) Accessory is connected to the device. The tubing is kinked and the device stops suddenly.	5) Smooth the nasal cannula and tubing.
	6) Cooling fan which mounted inside the device stop running or rotate slowly, make the operating temperature is too hot.	6) Replace the cooling fan. Note: Cut off the power first. And perform by qualified personnel only.
	7) If the phenomenon is still appeared, the device can be used but please contact the supplier.	

If you have all other problems, TURN OFF the concentrator first, use your reserve oxygen supply, and contact the supplier immediately.



## OTHER ATTENTION ITEMS

### I . GAS PASS OPERATION SKETCH MAP

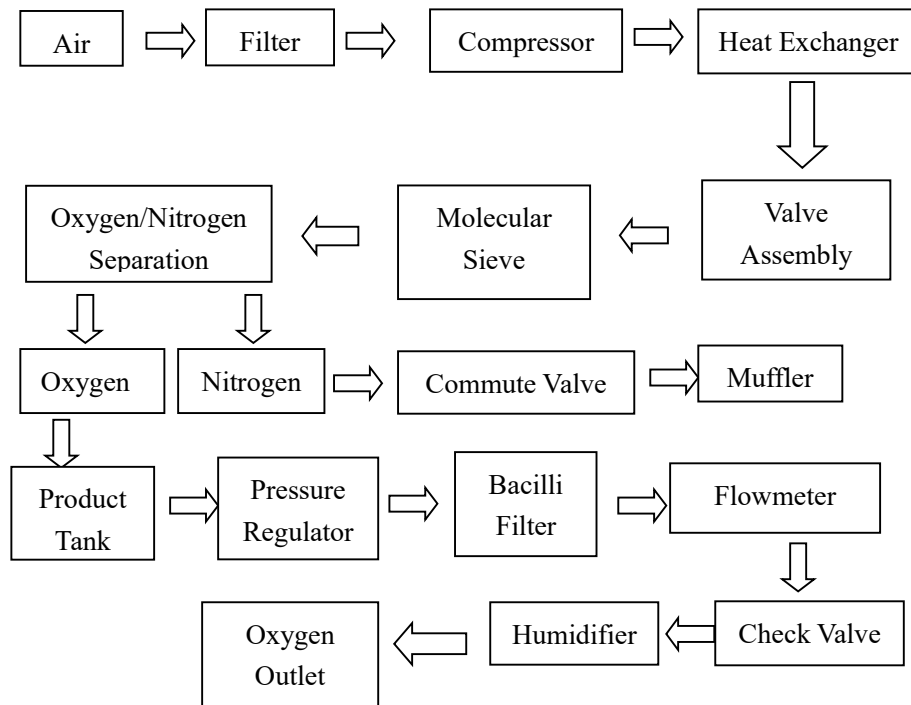

### II . ELECTRICAL RATIONALE

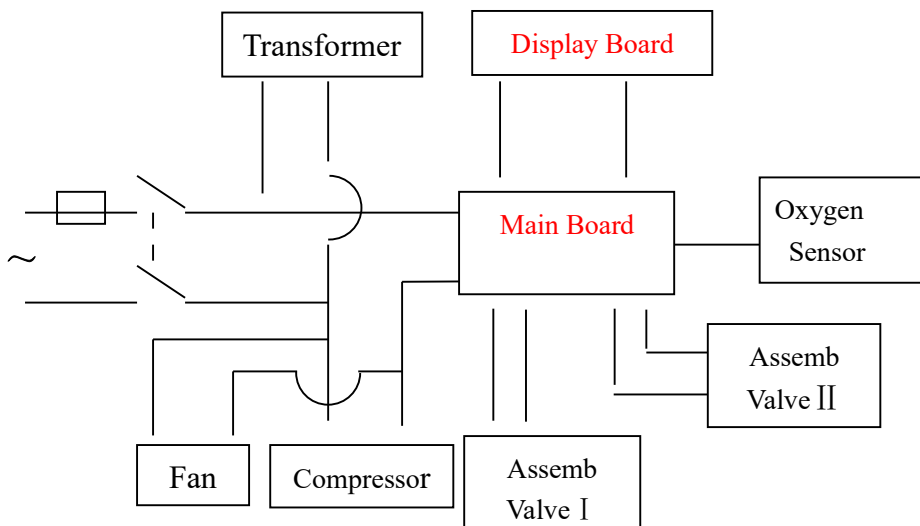

## **OTHER ATTENTION ITEMS**

---

### **III. PACKING LIST**

1. Oxygen Concentrator: 1 unit
2. **User & Technical Manual: 1 piece**
3. **Fuse tube: T5AH250V~/  $\phi 5 \times 20$ , 2pcs**
4. Firesafe Cannula Valve [ Bpr firesafe ] : 1 piece
5. **connect tube :  $\phi 5 \times \phi 9 \times 40$ mm silicone tube**
6. Nasal Oxygen Cannula 2m: 1 piece

### **IV. DEVICE DISPOSAL**

Contact the local cit or town offices for proper disposal instructions for oxygen concentrator.

## EMC Information

---



Use of this equipment adjacent to or stacked with other equipment should be avoided because it could result in improper operation. If such use is necessary, this equipment and the other equipment should be observed to verify that they are operating normally.



Use of accessories, transducers and cables other than those specified or provided by the manufacturer of this equipment could result in increased electromagnetic emissions or decreased electromagnetic immunity of this equipment and result in improper operation.



Portable RF communications equipment (including peripherals such as antenna cables and external antennas) should be used no closer than 30cm (12 inches) to any part of the Oxygen Concentrator, including cables specified by the manufacturer. Otherwise, degradation of the performance of this equipment could result.

### Electric and magnetic environment guidance in use

Guidance and declaration of manufacturer -Electromagnetic emission	
Emission test	Compliance
RF emissions CISPR 11	Group 1
RF emissions CISPR 11	Class B
Emission of harmonics IEC 61000-3-2	Class A
Voltage fluctuations / flicker emissions IEC 61000-3-3	Complies



## EMC Information

Guidance and declaration of manufacturer -Electromagnetic emission	
Immunity test	test level
Electrostatic discharge (ESD) IEC 61000-4-2	±8 kV contact ±15 kV Air
Electrical fast transient /bursts IEC 61000-4-4	±2 kV for power supply lines
Surge IEC 61000-4-5	±1 kV line to line
Voltage dips, short interruptions and Voltage variations on power supply input lines IEC 61000-4-11	0% $U_T$ 0.5 cycle at 0°, 45°, 90°, 135°, 180°, 225°, 270° and 315°
	0% $U_T$ 1 cycle 70% UT 25/30 cycles at 0°
	Voltage short interruptions : 0% UT 250/300 cycles at 0°
Power frequency (50 Hz) magnetic IEC 61000-4-8	30 A/m
Radiated RF EM fields IEC 61000-4-3	10V/m 80MHz – 2.7GHz 80% AM at 1kHz
Conducted disturbances induced by RF fields IEC 61000-4-6	3V/m 0.15MHz – 80MHz 6V in ISM and amateur radio bands between 0.15MHz and 80MHz 80% AM at 1kHz
Note: $U_T$ is the a.c. mains voltage prior to application of the test level.	

## EMC Information

Test specifications for ENCLOSURE PORT IMMUNITY to RF wireless communications equipment						
Test frequency (MHz)	Band (MHz)	Service	Modulation	Maximum power (W)	Distance (m)	IMMUNITY TEST LEVEL (V/m)
385	380 - 390	TETRA 400	Pulse modulation 18 Hz	1,8	0,3	27
450	430 - 470	GMRS 460, FRS 460	FM ±5 kHz deviation 1 kHz sine	2	0,3	28
710	704 - 787	LTE Band 13,17	Pulse modulation 217 Hz	0,2	0,3	9
745						
780						
810	800 - 960	GSM 800/900, TETRA 800, iDEN 820, CDMA 850, LTE Band 5	Pulse modulation 18 Hz	2	0,3	28
870						
930						
1720	1700 - 1990	GSM 1800; CDMA 1900; GSM 1900; DECT; LTE Band 1,3,4,25; UMTS	Pulse modulation 217 Hz	2	0,3	28
1845						
1970						
2450	2400 - 2570	Bluetooth, WLAN, 802.11 b/g/n, RFID 2450, LTE Band 7	Pulse modulation 217 Hz	2	0,3	28
5240	5100 - 5800	WLAN 802.11 a/n	Pulse modulation 217 Hz	0,2	0,3	9
5500						
5785						

NOTE If necessary to achieve the IMMUNITY TEST LEVEL, the distance between the transmitting antenna and the ME EQUIPMENT or ME SYSTEM may be reduced to 1 m. The 1 m test distance is permitted by IEC 61000-4-3.

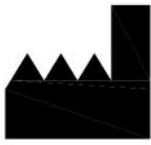

Jiangsu Yuyue Medical Equipment & Supply Co., Ltd.

Address: Yunyang Industrial Park, Danyang, Jiangsu, P.R.China

TEL: 86-511-86900833



Shanghai International Holding Corp. GmbH (Europe)

Address: Eiffestrasse 80, 20537 Hamburg Germany

TEL: 0049-40-2513175

**yuwell**



**Notified Body:**

**Name: TÜV SÜD Product Service GmbH**

**Address: Ridlerstr. 65, 80339 München, Germany**

**Document No.: YY-7F-3/5B-01 (B/1)**

**2019.06**